

Fiber-MOPA sources of coherent radiation

P.R. KACZMAREK*, G. SOBOŃ, J.Z. SOTOR, A.J. ANTOŃCZAK, and K.M. ABRAMSKI

Laser and Fiber Electronics Group, Institute of Telecommunication, Teleinformatics and Acoustics, Wrocław University of Technology,
27 Wybrzeże Wyspiańskiego St., 50-370 Wrocław, Poland

Abstract. This paper presents the concept and design of medium to high power fiber radiation sources in MOPA (Master Oscillator Power Amplifier) configuration. Research results are presented on a two-stage power amplifier for MOPA applications for the third telecommunications window at 1550 nm based on active erbium-doped and erbium/ytterbium-doped fibers. The amplifier is fabricated entirely in fiber technology and delivers several watts of output power.

Key words: fiber-MOPA sources, coherent radiation.

1. Introduction

Fiber sources of coherent radiation become an attractive alternative to traditional, solid state lasers which have been used up to now. Recently, a significant increase in available output power levels has been observed and the use of medium to high power fiber lasers is getting more and more common in a variety of industries [1]. The main reason for intensive work on the development of this field is that the active medium has very good thermo-optical properties, considerably better than those of the active media used in classical solid state lasers. Moreover, a fiber laser built based on the single-mode fiber doped with ions of rare earth elements (neodymium, ytterbium, erbium etc.) has excellent laser beam geometric parameters, and its wide gain band (several to several dozen nm) enables pulse operation with ultra-short pulses (below 100 fs).

Medium to high power fiber sources can be produced in two main ways. The first approach (classical) consists in building a high power fiber laser. This design is a natural development of the concept of solid state lasers and works well in the case of CW sources. Usually, pulse lasers require the use of bulk optical elements, which makes it hard to build fully fiber devices. High energy densities in the fiber lead to unfavourable non-linear effects, which are hard to eliminate [2]. Simultaneous control of multiple parameters of generated radiation is also very difficult. This can be overcome by another property of active fibers doped with ions of rare earth elements – the high gain. Fiber optics technology makes it possible to build a high power source using a low-power signal laser, with radiation amplified in a cascade of fiber amplifiers. This is the MOPA (Master Oscillator Power Amplifier) configuration. Control of high-power radiation parameters is implemented through the control of signal laser, which is far easier than direct control of the parameters of a high-power laser. Many low-power, tuneable, narrow bandwidth laser solutions are available, both for continuous operation and for pulse operation with gain switching or mode locking, which are perfectly suitable as radiation sources for MOPA configuration.

Additionally, such a cascade of amplifiers can be successfully implemented in traditional applications of fiber lasers, wherever a appropriately high output power is required (standard WDM systems [3], passive optical networks PON [4], deep space optical communications [5] or CATV amplifiers [6]).

A typical MOPA system consists of several (from two to four) fiber amplifiers connected to form a cascade [7]. Each subsequent stage delivers increasing output powers. The first stage of such an amplifier cascade is based on standard fiber amplifier technology – single-mode fiber doped with ions of rare earth elements with simultaneous propagation of amplifying and pumping radiation in the fiber core. In subsequent amplification stages double-clad fibers are used as active medium, which is due to the high pumping powers. In this configuration the radiation being amplified propagates in the active fiber core, while the pump in the multimode fiber clad of appropriately chosen shape [8]. Such a solution allows for much higher powers to be pumped through the fiber. In high power systems or pulsed systems output power is not constrained by the attainable pumping power, but rather by the non-linear effects (mainly the stimulated Brillouin and Raman scattering, SBS and SRS respectively) that enter into play at high energy densities within the fiber core. To minimize these effects LMA (Large Mode Area) fibers are used [9, 10]. The threshold for Brillouin scattering rises additionally due to the temperature gradient induced in the active fiber [11] or because of a specially designed active fiber shape [12].

2. Two stage amplifier cascade operating in the third telecommunications window

Initial assumptions for construction of a cascade system of fiber amplifiers must include several fundamental parameters. The first one is the selection of the wavelength, and consequently, the selection of the active dopant to be used in active fibers. In our case wavelengths from the third telecommunications window have been selected, which led us to use erbium- or erbium/ytterbium-doped active fibers. Another assumption

*e-mail: pawel.kaczmarek@pwr.wroc.pl

is the input power and the targeted output power. Because of the source we had available we decided for the input power of approx. 1mW and the amplifier cascade output power in the range of several watts. These assumptions mean that a two stage amplifier cascade will be required. The first stage is a classical EDFA amplifier, whereas the second stage must be based on a double-clad fiber. The fundamental issue for amplifiers using this type of fibers is that of choosing a method for coupling of the signal and the pumping power with the active fiber. Until recently the prevailing coupling methods were coupling from the front or several types of side coupling (with a prism, using diffraction grating, by fiber cutting etc.) based on standard bulk optics [13]. These types of solutions work well chiefly in laboratory applications, but high power fiber laser or amplifier systems were, in practice, commercially unavailable, which is due to the very high sensitivity to misalignment and the need for using precision mechanics. However, recent years have seen a major breakthrough in this field. Methods have been developed and implemented for entirely fiber-based coupling systems for transferring radiation to/from double-clad fibers [14–16] operating with high optical powers. These are multimode fiber couplers with an extra signal fiber (fiber power combiners). Solutions are now available in the market that allow for power levels of several hundred watts.

2.1. The first stage of the amplifier cascade. The first stage of MOPA is a typical signal amplifier based on a standard erbium-doped fiber. In these amplifiers one of the three typical configurations as in [17] is used: co propagating pumping, counter propagating pumping and bi-directional pumping. The co propagating pumping configuration is used for small signal amplifier operation, when minimum amplifier noise figure is required. The counter propagating pumping configuration is used when maximum saturated output power is needed. It is characterized by high output noise, particularly for small signal operation. The designed amplifier must demonstrate low noise and deliver the highest possible output power. Therefore, the most advantageous configuration seems to be the bi-directional pumping. It is a compromise configuration and offers low noise factor together with high power output. This type of pumping configuration provides one more benefit, namely it is possible to make direct use of two optical pumps. The amplifier output power depends directly on that of the pump. If the amplifier is pumped only from one side, in order to achieve a similar amplifier output power, one must double the power of pumping radiation to be injected into the pumping fiber. This means that pumping laser diodes with double output power will have to be used or extra connectors will have to be applied to collect pumping radiation into one common fiber using polarization optics or WDM technology. The selected configuration is shown in Fig. 1. The optical isolators being used protect the amplifier from lasing and eliminate signals that propagate backwards from the next stage of amplifier. The erbium-doped fiber is pumped from both sides through WDM fiber couplers which allow for the signal and the pump radiation to be injected

into one single-mode fiber. As pumping diodes the Bookham LC96UF76-20R semiconductor lasers are used, operating at 976 nm and delivering over 600 mW of output power in the fiber.

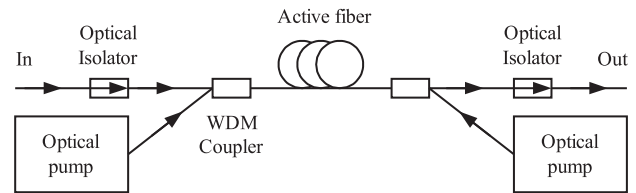

Fig. 1. Schematic of the EDFA amplifier – first stage of the amplifier cascade

The last element in the amplifier is the active fiber. In our case the LIEKKI ER80-4/125 erbium-doped fiber was used. This fiber, with a very high dopant concentration, is dedicated for use in pulse-mode amplifiers and fiber lasers. Fiber length was optimized experimentally in a series of amplifier parameter measurements, while the active fiber length was being gradually reduced. For the assumed input power 0dBm the optimum fiber length turned out to be 1.1 m. Longer fiber leads to slightly wider gain band, but amplifier noise parameters deteriorate. Shorter active fiber does not allow for very high gain levels. Figure 2 shows the spectral characteristic of amplifier output power.

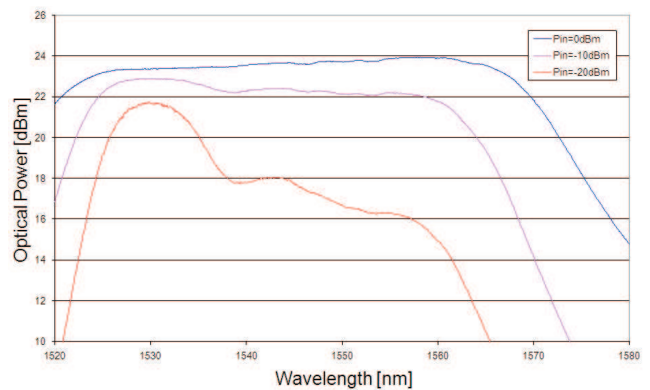

Fig. 2. Spectral characteristic of amplifier output power for three input power values

In a wide band, the obtained output power has been 23 dBm, with noise factor (NF) below 4.5 dB.

2.2. The power stage of the amplifier cascade. The second stage of the amplifier cascade, shown in Fig. 3, is based on an active, double-clad fiber, the SM-EYDF-7/130 manufactured by Nufern. The parameters of its core are similar to those of a standard SMF-28 telecom fiber. Its clad has a 130 μm diameter, an octagonal cross-section and a 0.46 numerical aperture. The outer clad is made of a low refractive index polymer.

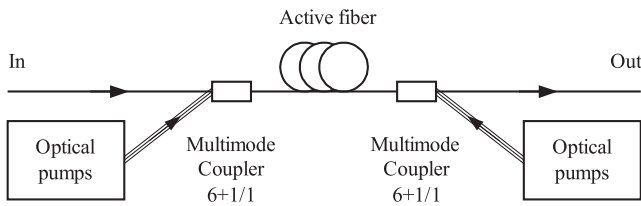

Fig. 3. Second stage of the amplifier cascade

The active core of this fiber is erbium/ytterbium-doped, which allows for high and broadband absorption (Fig. 4a shows the measured absorption characteristic for SM-EYDF-7/130). In these types of fibers pumping is concerned with the ytterbium ions and energy is transferred to the ions of erbium [18].

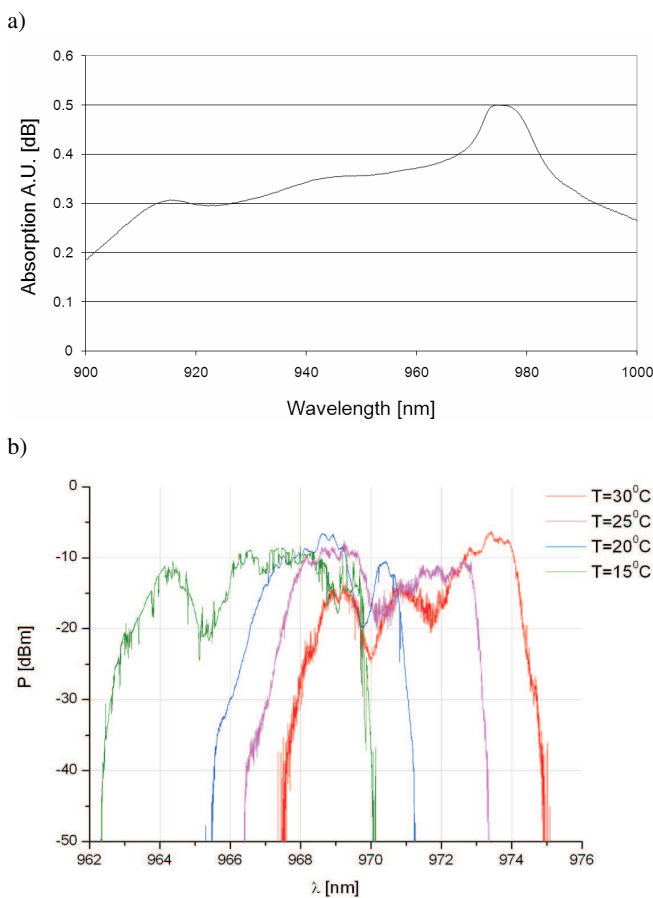

Fig. 4. Characteristics of optical pumping: a) spectrum of absorption in the first clad of the SM-EYDF-7/130; b) spectral characteristic of a laser diode at selected temperatures

As optical pumps we used the JDSU L4-9897510-100E 975 nm 10 W laser diodes, each of which was pigtailed into a standard multimode fiber with a 105 μm core diameter and a 0.22 numerical aperture. In the experiments we used alternatively a single pumping diode and a system consisting of two such lasers. Each pumping system (10 W or 20 W) was located on a purpose-designed water-block module connected with thermoelectric Peltier elements. This allowed for

high-precision temperature control of pumping lasers, indispensable for accurate tuning of the pump wavelength into the ytterbium absorption peak at 975 nm (Fig. 4b shows spectral characteristics of the pumping lasers used). Due to pumping at the wavelength that coincided with the absorption maximum, the optimal active fiber length considerably decreased – an active fiber of only seven meters allowed for absorption of over 95% of pumping power. A fiber that is short is advantageous for minimization of non-linear effects. On the other hand, the requirement of temperature stability of pumping lasers and the greatly increased thermal load of the active fiber are disadvantageous and curb the maximum pumping power.

In order to input the optical pump signal and to output the amplified signal from the active double-clad fiber, a multimode TFB-550612B72 (6+1)x1 fiber coupler was used. This coupler has six pumping inputs, with multimode fibers having 105 μm cores and 0.22 numerical apertures, and one signal input – a standard SMF-28 telecom fiber. The outer fiber is an undoped (passive) double-clad fiber. Its core has parameters similar to those of the SMF-28 telecom fiber; the first clad has a 125 μm diameter and a 0.22 numerical aperture. The second clad of this fiber constitutes a low refractive index polymer jacket. Geometrical and optical parameters of the coupler output fiber are very similar to those of an active fiber. This allows for a relatively simple connection between these elements, by means of standard fiber-splicing techniques. To resecure the splicing area the use of a high optical quality polymer with low refractive index was required so as to eliminate losses and the risk of thermal damage of uncovered cladding conducting the pumping power.

Another important element of the system is the second multimode fiber coupler, of the same type as the one used for pumping. This coupler outputs the unabsorbed pumping power at the other end of the active fiber. Such a solution allows for easy monitoring of absorption levels and helps to accurately set the temperature of the pumping diodes.

3. Experimental results

Figure 5 shows the schematic diagram of the measuring system built for the amplifier cascade. A tuneable CW laser delivering 1 mW was used as a low power radiation source. The first stage of the amplifier cascade is an EDFA amplifier with over 200 mW of output power. Between this amplifier and the end stage a 1% directional coupler is installed. It serves two purposes: first, to enable measurements of the characteristics and the parameters of the first stage, and second, to allow for monitoring of backpropagated signals from the second stage of the cascade, potential hazardous for the output isolator in the EDFA amplifier.

The amplified signal output ends with a FC/APC angle connector that minimizes signal reflections. To monitor the EDFA amplifier outputs a coupler was used to decouple 0.1% of output power. Use of an optical isolator in the monitoring block ensures full elimination of ytterbium ASE noise from the second stage of amplifier cascade. Noise would dis-

tort the output power measuring results and could be a risk for the measuring equipment (optical spectrum analyzer).

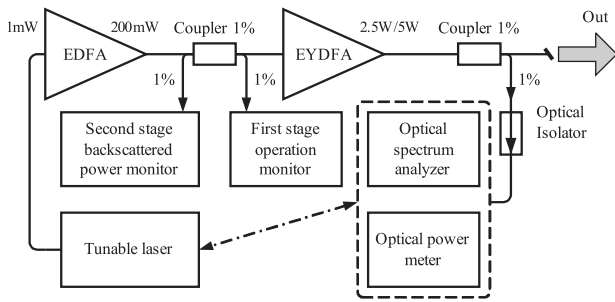

Fig. 5. Measurement circuit for the built MOPA configuration

Measurements of characteristics were carried out for two variants of pumping: pumping with a single 10 W laser diode and pumping with a system of two laser diodes, 10 W each. Figure 6 shows the characteristics of gain spectrum for three values of input power. It can be seen that the plots are flat, i.e. the gain is constant in a wide wavelength range. For input power values below the nominal value, the amplifier bandwidth shrinks.

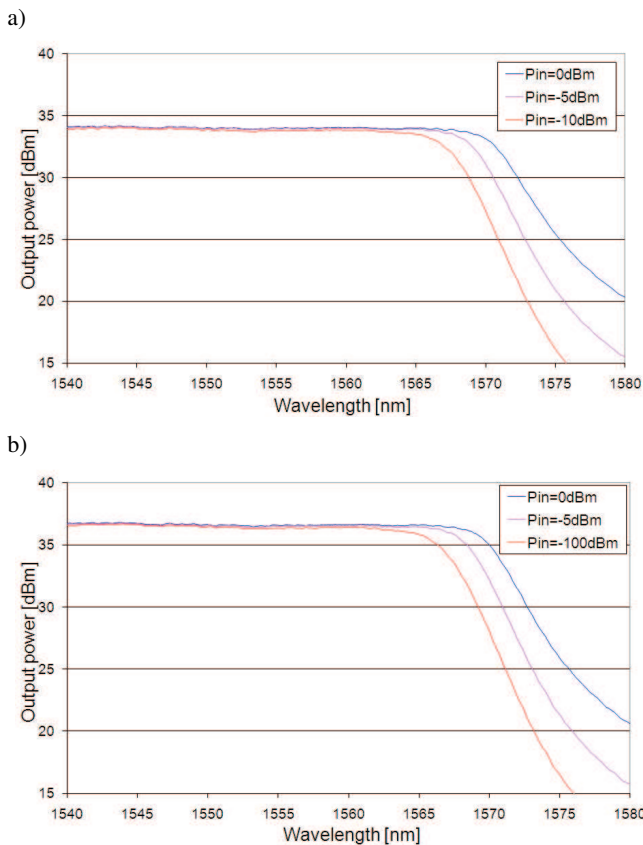

Fig. 6. Spectral characteristics of optical power on the output for three signal laser power values: a) for 10 W pumping power, b) for 20 W pumping power

Additionally, in such a case, there is a sharp increase in ASE noise, as shown in Fig. 7a. For minimum input power

OSNR is over 50 dB. As the input power falls, the ASE noise grows up to its maximum value for no input signal.

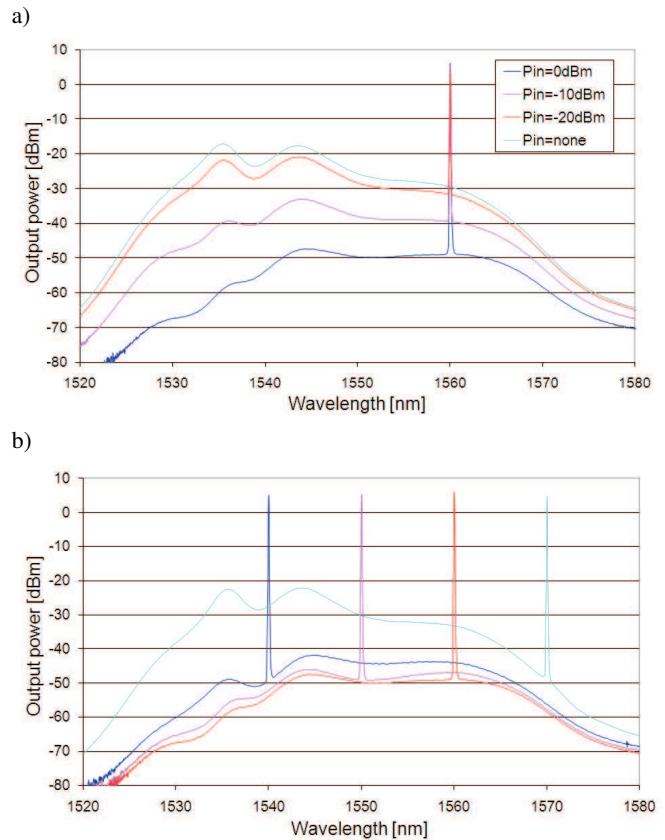

Fig. 7. Optical spectrum of output signals: a) ASE noise on the cascade output vs. input signal power, b) output signal spectrum for four wavelengths for 0 dBm input power

Figure 7b shows the spectra of input signals for nominal input powers. As can be seen, despite the high gain at 1570 nm amplifier noise properties are significantly worse than within its operating range, 1540-1565 nm. Amplifier noise factor for this range varies between 4.5 and 5 dB.

For the system that has been developed, measurements have been carried out of the transition characteristics of the dependence between the amplifier cascade output power and the pumping power of the last stage. Such characteristics allow for estimation of amplifier efficiency. Results for 10 W and 20 W of pumping power are shown in Fig. 8. As can be seen, these characteristics are non-standard (non-linear). This is due to the variation in the pumping diode wavelength as the supply current changes. This phenomenon will be clearly visible if we look at the plot of the power that is not absorbed in the active fiber. For approximately half the maximum power of the pump its spectrum starts to overlap with the absorption peak of ytterbium at 975 nm, resulting in increased absorption and increased optical efficiency of the last stage.

For the 10 W and 20 W optical pump power the obtained output power is over 2.5 W and over 4.6 W, respectively. Taking into account the input signal (0.2 W), the obtained optical efficiency is 24 and 23%, respectively.

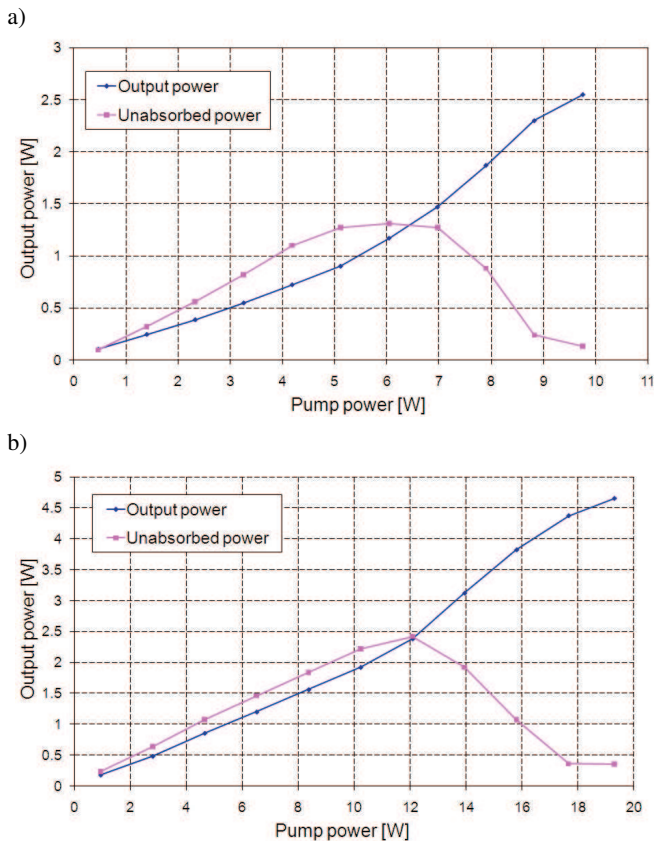

Fig. 8. Output power and unabsorbed power vs. pumping power: a) pumping with one 10 W laser diode, b) pumping with two 10 W laser diodes

4. Summary

This work presents the design and optimization of a two-stage amplifier cascade for MOPA configurations. The key advantage of the proposed solution is that the device is fabricated entirely in fiber technology. This eliminates the need for high-precision fiber-alignment systems and allows for considering a compact package for the device, fully resistant to external influences. The resulting device has satisfactory parameters – wide operating range and good noise properties. The amplifier that has been built could be described as a universal design suitable for use wherever optical signals of a few watts are required at the wavelength of the third telecommunications window.

Acknowledgements. This research is being carried out under the Research and Development Project No R02 0007 04 “Fiber Power Amplifiers for MOPA (Master Oscillator Power Amplifier) Configuration”, supported by the National Centre for Research and Development (NCBiR, Poland).

REFERENCES

- [1] J. Nilsson, Y. Jeong, J.K. Sahu, V.N. Philippov, D.B.S. Soh, C.A. Codemard, P. Dupriez, J. Kim, D.J. Richardson, A. Malinowski, A.N. Piper, J.H.V. Price, K. Furusawa, W.A. Clark-

son, and D.N. Payne, “High-power fiber lasers: progress and opportunities”, *14th Int. Laser Physics Workshop 1*, CD-ROM (2005).

- [2] Y. Wang, A. Martinez-Rios, and H. Po, “Experimental study of stimulated Brillouin and Raman scatterings in a Q-switched cladding-pumped fiber laser”, *Optical Fiber Technology* 10 (2), 201–214 (2004).
- [3] P. Wysocki, T. Wood, A. Grant, D. Holcomb, K. Chang, M. Santo, L. Braun, and G. Johnson, “High reliability 49 dB Gain, 13 W PM fiber amplifier at 1550 nm with 30 dB PER and record efficiency”, *Optical Fiber Conf. (OFC) PDP17*, CD-ROM (2006).
- [4] J.H. Lee, C.H. Kim, Y.-G. Han, and S.B. Lee, “Broadband, high power, erbium fibre ASE based CW supercontinuum source for spectrum-sliced WDM PON applications”, *Electronics Lett.* 42 (9) 67–68 (2006).
- [5] M.W. Wright and G.C. Valley, “Yb-doped fiber amplifier for deep-space optical communications”, *J. Lightwave Tech.* 23 (3), 1369–74 (2005).
- [6] D. Anthon, J. Fisher, M. Keur, K. Sweeney, and D. Ott, “High power optical amplifiers for CATV applications”, *Optical Fiber Communication Conf. and Exhibit OFC 2*, Tu11-1-Tu11-3 (2001).
- [7] J. Nilsson, J.K. Sahu, Y. Jeong, V.N. Philippov, D.B.S. Soh, C. Codemard, P. Dupriez, J. Kim, D.J. Richardson, A. Malinowski, A.N. Piper, J.H.V. Price, K. Furusawa, W.A. Clarkson, and D.N. Payne, “High power fiber lasers”, *Optical Fiber Communication Conf. 2*, CD-ROM (2005).
- [8] H.R. Muller, J. Kirchof, V. Reichel, and S. Unger, “Fibers for high power lasers and amplifiers”, *C.R. Physique* 7, 154–162 (2006).
- [9] A. Liem, H. Zellmer, and A. Tunnermann, “100-W single-frequency master-oscillator fiber power amplifier”, *Optics Letters* 28 (17), 1537–1539 (2003).
- [10] A. Liem, T. Schreiber, H. Zellmer, and A. Tunnermann, “Power scaling of cw high power fiber lasers based on large-mode-area fibers”, *CLEO/Europe Proc.* 1, 624–625 (2003).
- [11] D.N. Payne, “Kilowatt-class single-frequency fiber sources”, *Proc. SPIE* 5709, 133–41 (2005).
- [12] S. Gray, D. Walton, J. Wang, Ming-Jun Li, X. Chen, A.B. Ruffin, J. Demeritt, and L. Zenteno, “High power, narrow linewidth fiber amplifiers”, *Optical Amplifiers and Their Applications OSuB12*, CD-ROM (2006).
- [13] A.J. Zajac, J. Świdorski, P. Konieczny, and S. Gągała, *Fiber Lasers. Analysis and Design Requirements*, WAT Publishing House, Warszawa, 2007, (in Polish).
- [14] F. Gonthier, “High-power All-Fiber components: the missing link for high-power fiber lasers”, *Proc. SPIE* 5335, 266–276 (2004).
- [15] T.F. Morse and F. Luo, “A novel pump combiner for high power fiber lasers”, *Digest LEOS Summer Topical Meetings* 1, 7–8 (2006).
- [16] R.G. Waarts, “Fiber lasers at JDS Uniphase”, *Proc. SPIE* 5335, 217–228 (2004).
- [17] E. Desurvire, *Erbium-doped Fiber Amplifiers Principles and Applications*, John Wiley & Sons, New York, 1994.
- [18] Z.G. Lu, J.R. Liu, F.G. Sun, G.Z. Xiao, and P. Lin, “A hybrid fiber amplifier with 36.9-dBm output power and 70-dB gain”, *Optics Comm.* 256 (4–6), 352–57 (2005).